

TWIST-LOCK SERIES FOR pH or ORP APPLICATIONS

6/07

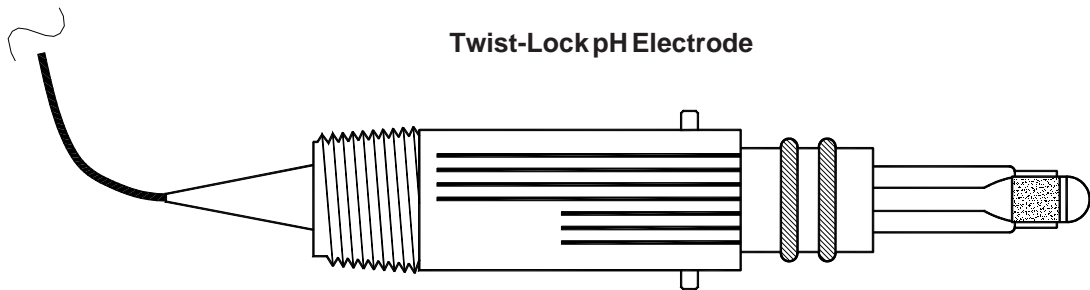

6103 GLENMONT • HOUSTON, TEXAS • 77081
800/522-7920 • FAX 713/772-4671 • 713/772-6641
www.VL-PC.com



Twist-Lock pH Electrode

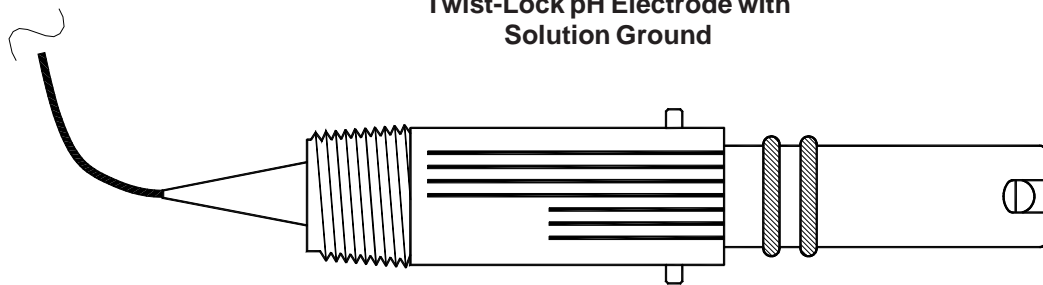

Twist-Lock pH Electrode with
Solution Ground

Twist-Lock Adapter

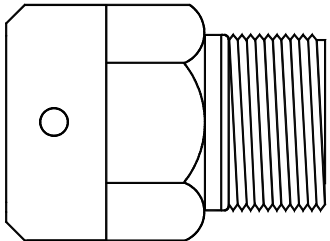

Guarded Twist-Lock
Adapter

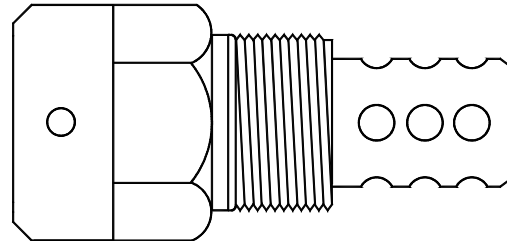

- **Low Cost Replacements**
Long-lasting, reliable, and low in cost for pH and ORP sensors. Twist-Lock housing design allows for an all-in-one electrode or sensor replacement to reduce inventory requirements.
- **Safe Operation**
A stop pin is installed in the adapters for positive electrode/sensor positioning; locking pins on the housing are visible through an opening 90° from the removal slots to assure correct installation.

- **Housing Features**
¼ turn is all that is required for installation. The housing is ribbed for easy handling.
- **O-ring Arrangement**
Dual external o-rings and an internal o-ring seal the electrode from any process leakage.
- **Quality "Built In"**
All parts meet strict, documented quality specifications, followed through each step of the manufacturing process.

DESCRIPTION

The Twist-Lock sensor and adapter is designed to convert a standard pipe tee into a low cost, low maintenance flow-through sensor assembly. Only a ¼ turn is required for field maintenance or sensor replacement; threading is eliminated. The adapter is available in a variety of materials & connection sizes for easy installation.

APPLICATION

The Van London-Phoenix Co. Twist-Lock mounting system provides continuous pH, ORP, or Conductivity monitoring with safe and convenient service capability for any flow-through system. Typical installations include by-pass streams, sample systems, or sensor stations.

SPECIFICATIONS

Pressure Rating: 150 PSI *
Temperature Range: ** 130°C (266°F)
Process Connections: ½", ¾", 1" and 1½"
Conduit Connection: ¾" MPT
O-Ring Seals: ***Viton™ (standard)
pH Range: 0-14

Reference Style: Double junction Ag/AgCl with **Solid Polymer Reference**

* V-110Z, V-120Z, and V-130Z (100 PSI max)

** Recommend metallic Twist-Lock adapter for process temperatures above 80°C (176°F)

*** Other Materials available

Dimensional and Mounting Detail

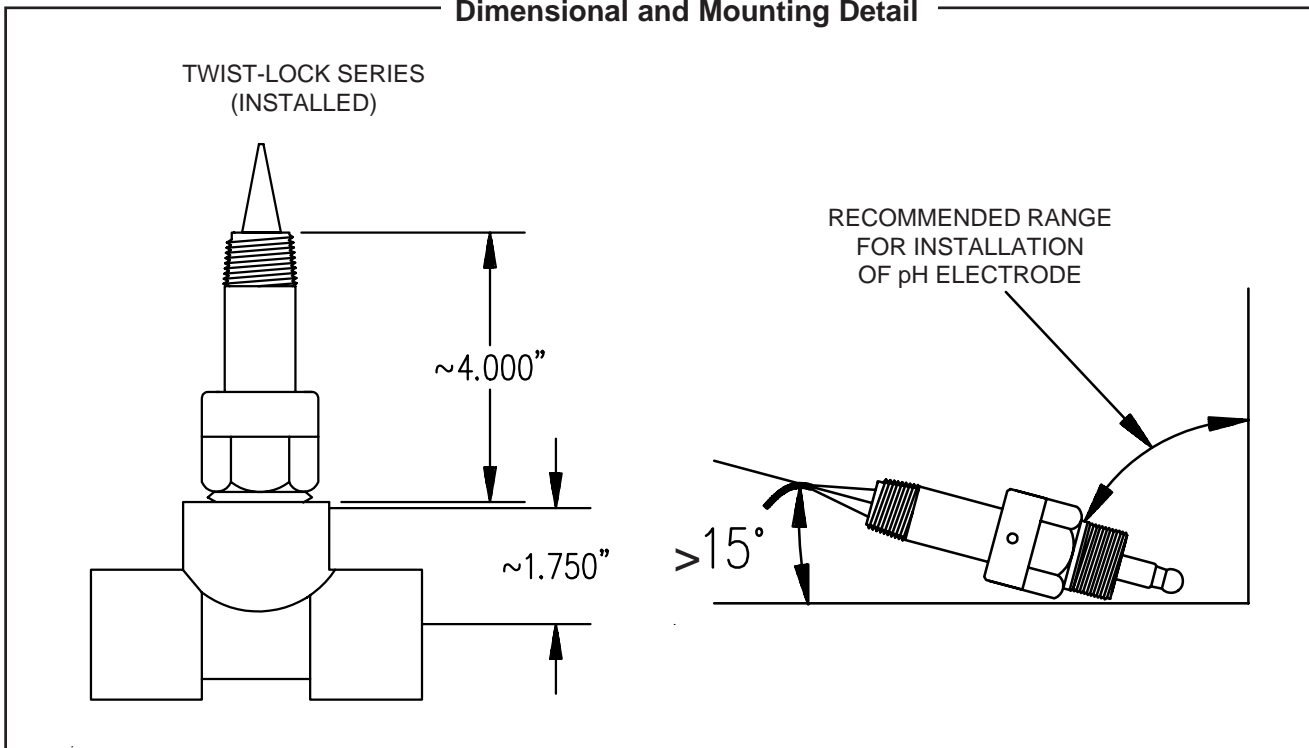

ORDERING INFORMATION

- Adapters, tees, electrodes and sensors are all sold separately. A Twist-Lock adapter is required for initial installation.
- To build your own part number, first determine the electrode or sensor style required and then replace **X**'s, **Z**'s, and **Q**'s with selections listed in the drop-down menus on the back page.
- Call the factory if electrode application assistance is required. Conversion information is also available for quick replacement of existing installations.

pH SENSOR SELECTION

V-100Z	-	XX QQ:	Twist-Lock pH Electrode (Ryton®)
V-110Z	-	XX QQ:	Twist-Lock pH Electrode (Ryton® & 316 SS Solution Ground)
V-120Z	-	XX QQ:	Twist-Lock pH Electrode (Kynar®)
V-130Z	-	XX QQ:	Twist-Lock pH Electrode (Teflon®)

Connector Type

B BNC
H Stripped & Soldered Wire Tips
BH Male BNC & Hanked (tinned)
F 4-Pin Military (Male)

Lead Length

Specify lead length in even feet.

Automatic Temperature Compensator (ATC)

1 3,000 ohm
7 300 ohm
9 8,525 ohm
B 100 ohm
E 1,000 ohm

ORP SENSOR SELECTION

1906644 - XX QQ: Twist-Lock ORP Electrode (Ryton®)

Temperature Compensator Optional

CONNECTORS

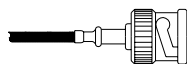

BNC



Hanked



BNC & Hanked

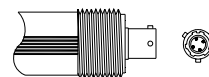

Type F

ELECTRODE SOLUTIONS

9210038	4.00pH, 7.00pH and Deionized Water rinse (1 pint each)
9210037	4.00pH, 7.00pH and 10.00pH (1 pint each)
9210039	7.00pH, 10.00pH and Deionized Water rinse (1 pint each)
9210079	Anti-fouling solution to reduce electrode-coating problems
9210008-125	Electrode storage solution KCl/4.00 pH buffer (125 ml)

TWIST-LOCK ADAPTERS

1600143	: Kynar Twist-Lock Adapter, 1" MPT
1600143G	: Kynar Twist-Lock Adapter, 1" MPT Guarded
1600142	: Kynar Twist-Lock Adapter, 3/4" MPT
1600142G	: Kynar Twist-Lock Adapter, 3/4" MPT Guarded
1500143	: Stainless Steel Twist-Lock Adapter, 1" MPT
1500143G	: Stainless Steel Twist-Lock Adapter, 1" MPT Guarded
1500142	: Stainless Steel Twist-Lock Adapter, 3/4" MPT
1500142G	: Stainless Steel Twist-Lock Adapter, 3/4" MPT Guarded

PIPE TEES

1502203	: Stainless Steel Pipe Tee, 1" FPT
1502202	: Stainless Steel Pipe Tee, 3/4" FPT
1602203	: Kynar Pipe Tee, 1" FPT
1602202	: Kynar Pipe Tee, 3/4" FPT

*Other accessories and materials are available.
Consult factory for options.*

Electrode Solutions

9210038	4.00pH, 7.00pH and Deionized Water rinse (1 pint each)
9210037	4.00pH, 7.00pH and 10.00pH (1 pint each)
9210039	7.00pH, 10.00pH and Deionized Water rinse (1 pint each)
9210079	Anti-fouling solution to reduce electrode-coating problems
9210008-125	Electrode storage solution KCl/4.00 pH buffer (125 ml)

TRANSMITTER REFERENCE GUIDE

<u>Tranmitter</u>	<u>Temp. Comp.</u>	<u>Cable Connector</u>
Yokogawa	B	H
ABB/TBI 515	1	BS
ABB/TBI TB82 & TB84	B	H
Rosemount:		
1181 w/ preamp in transmitter	*	SL
1181 w/ remote preamp	*	BH
2081,3081,4081,5081,1055 & XMT	B	H
Honeywell w/ preamp	9	H
Ingold/Mettler Toledo	B	H
Endress & Hauser	B	H
Foxboro	B	H
Great Lakes Inst.	B (conventional)	H
Great Lakes Inst.	7 (differential)	

* Preamp dependant - Consult Van London-Phoenix Co. sales staff.

Additional electrode styles, materials, buffer solutions & wiring adapters are available.



Please contact our Asia Pacific distributor:

H2O Rx

Phone: 0409 784 236 or 0421 795 353
info@h2orx.com.au

www.h2orx.com.au

SPR is a trademark of Van London-

u Pont de Nemours & Co.
[Twist-Lock.pmd]